

This laboratory grown diamond was created by the CVD (Chemical Vapor Deposition) method and has the same chemical, physical, and optical properties as a mined diamond. This diamond is Type IIa.

**8X** is the ultimate achievement in precision diamond cutting. Only extraordinarily brilliant and beautiful diamonds achieve **EXCELLENT** grades in all **EIGHT** aspects of CUT quality assessment.

# LAB GROWN DIAMOND

**GICAL LG342276153**

September 04, 2024



## 4C's GRADING

Carat Weight **1.02**  
Color **E**  
Clarity **VVS2**  
Cut **8X**

|                         |  |
|-------------------------|--|
| Certificate No          | <b>GICAL LG342276153</b>               |
| Identification          | <b>Lab Grown Diamond</b>               |
| Shape and Cutting Style | <b>Princess</b>                        |
| Measurements            | <b>5.54 x 5.49 x 3.86mm</b>            |
| Fluorescence            | <b>None</b>                            |
| Girdle                  | <b>Thin to Sl.Thick</b>                |
| Culet                   | <b>None</b>                            |
| Inscription             | <b>LAB GROWN, GICAL 8X LG342276153</b> |
| Growth Method           | <b>CVD</b>                             |



Gemprint is the unique optical fingerprint of your lab grown diamond. This patented technology is positive, forensic identification.



Protect your investment by registering your lab grown diamond and receive discounts up to 10% off your annual insurance premiums. **Register your diamond at GEMPRINT.com**

## Laser Inscription

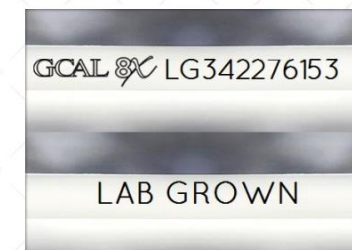
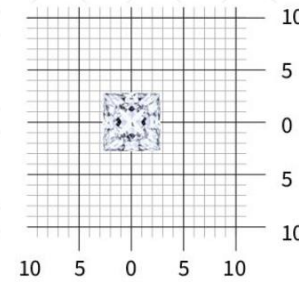

Illustration depicts approx. girdle appearance

## Actual Size



Measurements in millimeters (mm)

## Photomicrographs



Actual photographs of the crown and pavilion of this lab grown diamond. View hi-resolution photos at GICALUSA.com

### Clarity Characteristics and Locations

|           |                            |
|-----------|----------------------------|
| Pinpoints | Table, Crown Corner, Crown |
| Feather   | Half Moon                  |

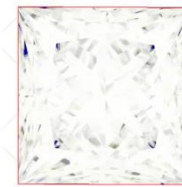

## Optical Brilliance

is the overall return of white light to the viewer. It is measured to the thousandth decimal place and is represented in this image. The white areas indicate light return / brilliance, and the dark-blue areas indicate light loss.



## Fire

results when white light travels through a diamond and is dispersed into its rainbow of spectral colors. These flashes of color contribute to sparkle and are best viewed as the diamond moves.

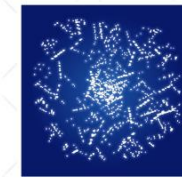

## Scintillation

is the flashes of white light, or sparkle, produced when light is reflected from a diamond as it moves. This image shows the light returned from a single beam of light when your lab grown diamond is rotated in nine positions.

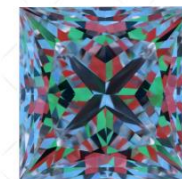

## Optical Symmetry

is visualized in this photograph of your lab grown diamond taken in a specific colored lighting environment. The evenness of the pattern illustrates the precision and uniformity of facet shapes and alignment.

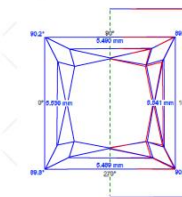

## Shape Aesthetics

analyzes features unique to Princess Cuts:

The angles and axis symmetry were assessed to confirm this princess cut is a desirable square shape, with a ratio between 1:1 to 1:1.015 and 90° corners within 0.2 +/- . The axis symmetry images shown here are part of these measurements.

Precise points or chamfered corners on princess cuts are inspected to ensure only diamonds with undamaged corners. at the time of inspection, achieve an Excellent grade.

**GICAL LG342276153 PR 1.02 E VVS2 8X**

Scan QR code to view photos and videos of this lab grown diamond, and the **8X** grading scale, or go to <https://www.gicalusa.com/c/342276153>



### 1. Polish

|                  |                  |                  |                        |                        |
|------------------|------------------|------------------|------------------------|------------------------|
| <b>P</b><br>Poor | <b>F</b><br>Fair | <b>G</b><br>Good | <b>VG</b><br>Very Good | <b>EX</b><br>Excellent |
|------------------|------------------|------------------|------------------------|------------------------|

### 2. External Symmetry

|                  |                  |                  |                        |                        |
|------------------|------------------|------------------|------------------------|------------------------|
| <b>P</b><br>Poor | <b>F</b><br>Fair | <b>G</b><br>Good | <b>VG</b><br>Very Good | <b>EX</b><br>Excellent |
|------------------|------------------|------------------|------------------------|------------------------|

### 3. Proportions

|                  |                  |                  |                        |                        |
|------------------|------------------|------------------|------------------------|------------------------|
| <b>P</b><br>Poor | <b>F</b><br>Fair | <b>G</b><br>Good | <b>VG</b><br>Very Good | <b>EX</b><br>Excellent |
|------------------|------------------|------------------|------------------------|------------------------|

### 4. Optical Brilliance

|                  |                  |                  |                        |                        |
|------------------|------------------|------------------|------------------------|------------------------|
| <b>P</b><br>Poor | <b>F</b><br>Fair | <b>G</b><br>Good | <b>VG</b><br>Very Good | <b>EX</b><br>Excellent |
|------------------|------------------|------------------|------------------------|------------------------|

### 5. Fire

|                  |                  |                  |                        |                        |
|------------------|------------------|------------------|------------------------|------------------------|
| <b>P</b><br>Poor | <b>F</b><br>Fair | <b>G</b><br>Good | <b>VG</b><br>Very Good | <b>EX</b><br>Excellent |
|------------------|------------------|------------------|------------------------|------------------------|

### 6. Scintillation

|                  |                  |                  |                        |                        |
|------------------|------------------|------------------|------------------------|------------------------|
| <b>P</b><br>Poor | <b>F</b><br>Fair | <b>G</b><br>Good | <b>VG</b><br>Very Good | <b>EX</b><br>Excellent |
|------------------|------------------|------------------|------------------------|------------------------|

### 7. Optical Symmetry

|                  |                  |                  |                        |                        |
|------------------|------------------|------------------|------------------------|------------------------|
| <b>P</b><br>Poor | <b>F</b><br>Fair | <b>G</b><br>Good | <b>VG</b><br>Very Good | <b>EX</b><br>Excellent |
|------------------|------------------|------------------|------------------------|------------------------|

### 8. Shape Aesthetics

|                  |                  |                  |                        |                        |
|------------------|------------------|------------------|------------------------|------------------------|
| <b>P</b><br>Poor | <b>F</b><br>Fair | <b>G</b><br>Good | <b>VG</b><br>Very Good | <b>EX</b><br>Excellent |
|------------------|------------------|------------------|------------------------|------------------------|

## Proportion Diagram

Optical scanning technology measures each facet and angle to produce an accurate, to-scale diagram of this lab grown diamond.

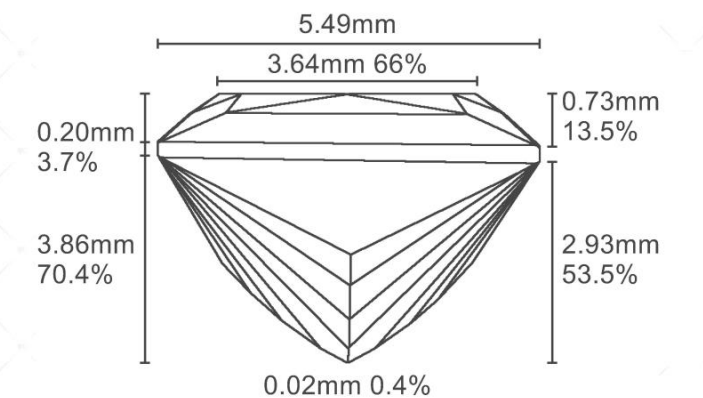

Gem Certification & Assurance Lab, Inc.  
ISO 17025 Accredited Forensic Laboratory

580 Fifth Ave LL-05,  
New York, NY 10036  
T 212-869-8985  
GICALUSA.com



ISO/IEC 17025 2017

ANAB L2177-1 Accredited Testing Lab



## DIAMOND SHAPES



## CARAT WEIGHT SIZES

| Carat Weight | 3.00   | 2.50   | 2.00   | 1.50   | 1.00   | 0.75   | 0.50   | 0.25   |
|--------------|--------|--------|--------|--------|--------|--------|--------|--------|
| Approx. Size |        |        |        |        |        |        |        |        |
| Diameter     | 9.20mm | 8.60mm | 8.00mm | 7.30mm | 6.40mm | 5.80mm | 5.10mm | 4.10mm |

## DIAMOND CLARITY GRADING SCALE

| FL                        | IF | VVS1                        | VVS2 | VS1                    | VS2 | S11               | S12 | I1               | I2 | I3 |
|---------------------------|----|-----------------------------|------|------------------------|-----|-------------------|-----|------------------|----|----|
| FLAWLESS - INTERNALLY FL. |    | VERY VERY SLIGHTLY INCLUDED |      | VERY SLIGHTLY INCLUDED |     | SLIGHTLY INCLUDED |     | INCLUDED / PIQUE |    |    |

## DIAMOND COLOR GRADING SCALE



## DIAMOND FLUORESCENCE GRADING SCALE



## DIAMOND POLISH & SYMMETRY GRADING SCALE



## BRILLIANT CUT DIAGRAM



# BUY WITH CONFIDENCE

## GCAL'S 4Cs GRADING GUARANTEE

The GCAL (Gem Certification & Assurance Lab) philosophy is simple. We believe consumers should feel confident about their diamond purchase, in the same way we believe experts should be accountable and stand behind their work.

This is why your lab grown diamond is protected by a zero tolerance, money-backed grading guarantee. You should be aware, and proud of the fact that GCAL is the only diamond grading lab in the world that fully guarantees the accuracy of its grading. If the carat weight, or any of the cut, color, or clarity grades provided in this GCAL Guaranteed Certificate prove to be of less weight or lower quality, GCAL will reimburse you the difference between what you paid and the current, fair retail value in the market level where you purchased it, of a lab grown diamond with the newly-established grades. For full details of the GCAL Consumer Guarantee, visit [GCALUSA.com](http://GCALUSA.com)

## GCAL'S MISSION STATEMENT

To provide the most accurate and consistent gemological grading, with uncompromising integrity and unparalleled customer service.

## GEMPRINT®

Having a traceable, unique "fingerprint" of your lab grown diamond adds future protection to your investment, as well as peace of mind. GCAL records the distinctive Gemprint of every diamond we certify. This patented technology for positive identification is recognized worldwide as forensic evidence and identification. Register your lab grown diamond at [GEMPRINT.com](http://GEMPRINT.com)

## CERTIFICATE VERIFICATION

You can verify the authenticity of this certificate by entering your GCAL Certificate number at [GCALUSA.com](http://GCALUSA.com). You can view the high resolution photographs and videos of your lab grown diamond from this certificate, and download a complimentary digital copy of this document to send to your insurance company.

## ISO 17025 ACCREDITATION

We believe challenging ourselves leads to better performance. That's why our methods and procedures are independently audited annually, ensuring we uphold the standards of the ISO 17025 Forensic Laboratory Accreditation. In fact, GCAL is the only ISO 17025 Forensic Accredited Gem Lab in the world!

**ONE LOCATION. ONE STANDARD. GRADED IN THE USA**



# GUARANTEED CERTIFICATE

## LAB GROWN DIAMOND

Independently Graded and Guaranteed by GCAL  
ISO 17025 Accredited Forensic Laboratory



**8X™** is the highest achievement in precision diamond cutting. The **GCAL 8X™** Ultimate Diamond Cut Grading System encompasses all aspects of diamond CUT quality assessment. Your lab grown diamond has achieved grades of Excellent in all eight aspects of CUT quality assessment. As a result, this lab grown diamond is recognized for its extraordinary brilliance and beauty.

## PHYSICAL EXCELLENCE

The first three of the 8X grading factors analyze the exactness of the Physical surface, the facet shapes, as well as the angles. This includes the Polish, External Symmetry and Proportions.

Decades of meticulous mathematical calculations have determined the narrow proportion ranges required to produce superior cut diamonds. Each shape has been studied individually to find the most aesthetically pleasing parameters. Some of the factors considered are listed below.

To view the proportion specifications for each shape, please visit our website [GCALUSA.com](http://GCALUSA.com)

|                       |                           |
|-----------------------|---------------------------|
| Table %               | Lower Girdle Facet Length |
| Depth %               | Star Length               |
| Crown Angle/Height    | Girdle Thickness          |
| Pavilion Angle/Height | Culet Size                |

## LIGHT PERFORMANCE EXCELLENCE

The next three of the 8X grading factors are Brilliance, Fire, and Scintillation, which analyze the light handling ability of your lab grown diamond. The combination of these factors is the essence of what makes any diamond visibly shine, dance and sparkle from across a room. Fire and Scintillation are graded while the diamond is in motion and interacting with light. View the Fire and Scintillation videos of this lab grown diamond at [GCALUSA.com](http://GCALUSA.com) or by scanning the QR code on this certificate.

## OPTICAL EXCELLENCE

The last two 8X grading factors consider optical excellence. These factors scrutinize the craftsmanship, the precise alignment of the crown and pavilion facets, the shape outline, and the length-width ratio, ensuring the lab grown diamond achieves aesthetic perfection.

Grading scales for each of the 8X grading factors can be viewed at [GCALUSA.com](http://GCALUSA.com)