

LAB GROWN DIAMOND

GICAL LG321711250

June 30, 2022



4C's GRADING

Carat Weight **3.29**
Color **G**
Clarity **VS1**
Cut **8XTM**

Certificate No **GICAL LG321711250**
Identification **Lab Grown Diamond**
Shape and Cutting Style **Round Brilliant**
Measurements **9.56-9.61x5.85mm**
Fluorescence **None**
Girdle **Medium to Sl.Thick, Faceted**
Culet **None**
Inscription **LAB GROWN, GICAL 8XTM LG321711250**

ONE LOCATION. ONE STANDARD. GRADED IN THE USA

Gem Certification & Assurance Lab has examined this lab grown diamond and certifies that the specifications noted in this document are accurate within recognized gemological tolerances. GICAL is an independent third-party and stands behind our grading with a 4Cs Consumer Guarantee. The guarantee, grading scales and all images unique to this lab grown diamond are available at GICALUSA.com.



Gem Certification & Assurance Lab, Inc.
ISO 17025 Accredited Forensic Laboratory

580 Fifth Ave LL-05,
New York, NY 10036
T 212-869-8985
GICALUSA.com



ISO/IEC 17025 2017

This laboratory grown diamond was created by the CVD (Chemical Vapor Deposition) method and has the same chemical, physical, and optical properties as a mined diamond. This diamond is Type II.



The fingerprint system for diamonds

Gemprint is the unique optical fingerprint of your lab grown diamond. This patented technology is positive, forensic identification.

Protect your investment by registering your lab grown diamond and receive discounts up to 10% off your annual insurance premiums. **Register your diamond at GEMPRINT.com**

Laser Inscription



Illustration depicts approx. girdle appearance

Actual Size

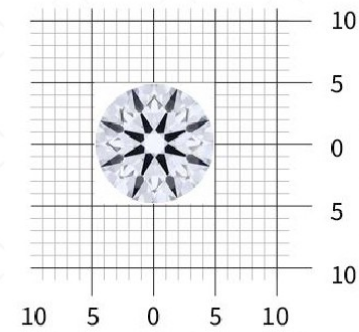

Measurements in millimeters (mm)

Photomicrographs



Actual photographs of the crown and pavilion of this lab grown diamond. View hi-resolution photos at GICALUSA.com

Clarity Characteristics and Locations

Crystals Table, Bezel

8XTM is the ultimate achievement in precision diamond cutting. Only extraordinarily brilliant and beautiful diamonds achieve **EXCELLENT** grades in all **EIGHT** aspects of CUT quality assessment.

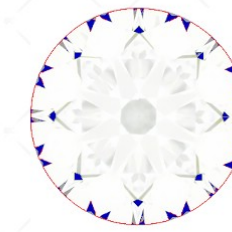

Optical Brilliance

is the overall return of white light to the viewer. It is measured to the thousandth decimal place and is represented in this image. The white areas indicate light return / brilliance, and the dark-blue areas indicate light loss.



Fire

results when white light travels through a diamond and is dispersed into its rainbow of spectral colors. These flashes of color contribute to sparkle and are best viewed as the diamond moves.



Scintillation

is the flashes of white light, or sparkle, produced when light is reflected from a diamond as it moves. This image shows the light returned from a single beam of light when your lab grown diamond is rotated in nine positions.

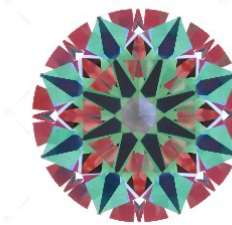

Optical Symmetry

is visualized in this photograph of your lab grown diamond taken in a specific colored lighting environment. The evenness of the pattern illustrates the precision and uniformity of facet shapes and alignment.



Hearts & Arrows

Precision faceting is visualized as Hearts & Arrows when round brilliant cut diamonds are viewed in specific lighting conditions. Each pattern is the result of superior facet placement and exact alignment.



GICAL LG321711250 RB 3.29 G VS1 8XTM

Scan QR code to view photos and videos of this lab grown diamond, and the **8XTM** grading scales, or go to <https://www.gicalusa.com/c/321711250>



1. Polish

P Poor F Fair G Good VG Very Good EX Excellent

2. External Symmetry

P Poor F Fair G Good VG Very Good EX Excellent

3. Proportions

P Poor F Fair G Good VG Very Good EX Excellent

4. Optical Brilliance

P Poor F Fair G Good VG Very Good EX Excellent

5. Fire

P Poor F Fair G Good VG Very Good EX Excellent

6. Scintillation

P Poor F Fair G Good VG Very Good EX Excellent

7. Optical Symmetry

P Poor F Fair G Good VG Very Good EX Excellent

8. Hearts & Arrows

P Poor F Fair G Good VG Very Good EX Excellent

Proportion Diagram

Optical scanning technology measures each facet and angle to produce an accurate, to-scale diagram of this lab grown diamond.

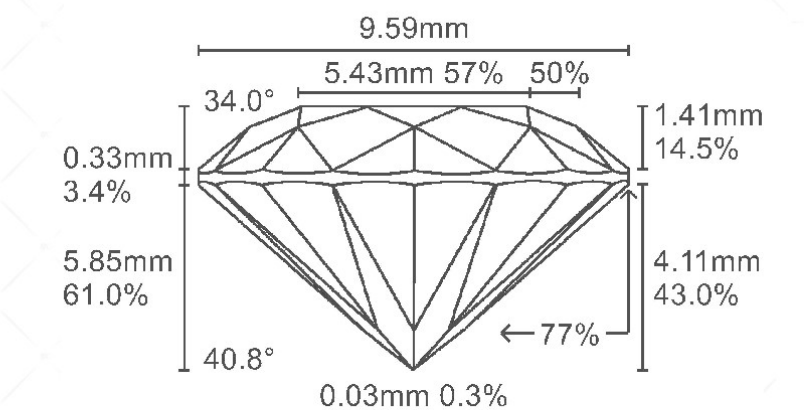

DIAMOND SHAPES



CARAT WEIGHT SIZES

Carat Weight	3.00	2.50	2.00	1.50	1.00	0.75	0.50	0.25
Approx. Size								
Diameter	9.20mm	8.60mm	8.00mm	7.30mm	6.40mm	5.80mm	5.10mm	4.10mm

DIAMOND CLARITY GRADING SCALE

FL	IF	VVS1	VVS2	VS1	VS2	S11	S12	I1	I2	I3
FLAWLESS - INTERNALLY FL.		VERY VERY SLIGHTLY INCLUDED		VERY SLIGHTLY INCLUDED		SLIGHTLY INCLUDED		INCLUDED / PIQUE		

DIAMOND COLOR GRADING SCALE

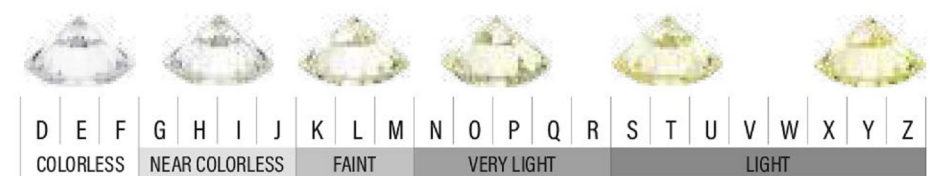

D - Z DIAMOND COLOR GRADING SCALE

DIAMOND FLUORESCENCE GRADING SCALE

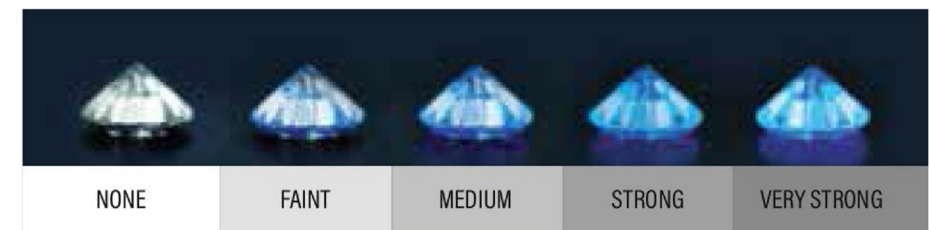

DIAMOND POLISH & SYMMETRY GRADING SCALE



ROUND BRILLIANT CUT DIAGRAM

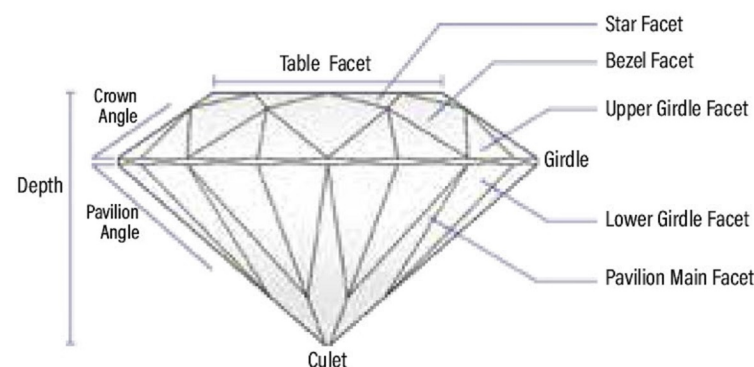

BUY WITH CONFIDENCE

GCAL'S 4Cs GRADING GUARANTEE

The GCAL (Gem Certification & Assurance Lab) philosophy is simple. We believe consumers should feel confident about their diamond purchase, in the same way we believe experts should be accountable and stand behind their work.

This is why your lab grown diamond is protected by a zero tolerance, money-backed grading guarantee. You should be aware, and proud of the fact that GCAL is the only diamond grading lab in the world that fully guarantees the accuracy of its grading. If the carat weight, or any of the cut, color, or clarity grades provided in this GCAL Guaranteed Certificate prove to be of less weight or lower quality, GCAL will reimburse you the difference between what you paid and the current, fair retail value in the market level where you purchased it, of a lab grown diamond with the newly-established grades. For full details of the GCAL Consumer Guarantee, visit GCALUSA.com

GCAL'S MISSION STATEMENT

To provide the most accurate and consistent gemological grading, with uncompromising integrity and unparalleled customer service.

GEMPRINT®

Having a traceable, unique "fingerprint" of your lab grown diamond adds future protection to your investment, as well as peace of mind. GCAL records the distinctive Gemprint of every diamond we certify. This patented technology for positive identification is recognized worldwide as forensic evidence and identification. Register your lab grown diamond at GEMPRINT.com

CERTIFICATE VERIFICATION

You can verify the authenticity of this certificate by entering your GCAL Certificate number at GCALUSA.com. You can view the high resolution photographs and videos of your lab grown diamond from this certificate, and download a complimentary digital copy of this document to send to your insurance company.

ISO 17025 ACCREDITATION

We believe challenging ourselves leads to better performance. That's why our methods and procedures are independently audited annually, ensuring we uphold the standards of the ISO 17025 Forensic Laboratory Accreditation. In fact, GCAL is the only ISO 17025 Forensic Accredited Gem Lab in the world!

ONE LOCATION. ONE STANDARD. GRADED IN THE USA



GUARANTEED CERTIFICATE



LAB GROWN DIAMOND

Independently Graded and Guaranteed by GCAL
ISO 17025 Accredited Forensic Laboratory



8X™ is the highest achievement in precision diamond cutting. The **GCAL 8X™** Ultimate Diamond Cut Grading System encompasses all aspects of diamond CUT quality assessment. Your lab grown diamond has achieved grades of Excellent in all eight aspects of CUT quality assessment. As a result, this lab grown diamond is recognized for its extraordinary brilliance and beauty.

PHYSICAL EXCELLENCE

The first three of the 8X grading factors analyze the exactness of the physical surface, the facet shapes, as well as the angles. This includes the Polish, External Symmetry and Proportions.

Decades of meticulous mathematical calculations have determined that these are the narrow proportion ranges required to produce superior Ideal round brilliant cut diamonds.

Table %	54.0% to 58.0%
Depth %	59.8% to 62.2%
Crown Angle	34.0° to 35.0°
Pavilion Angle	40.6° to 41.0°
Lower Girdle Facet Length	75% to 80%
Star Length	45% to 55%
Girdle Thickness	Thin to Slightly Thick, Faceted
Culet Size	None to Very Small

LIGHT PERFORMANCE EXCELLENCE

The next three of the 8X grading factors are Brilliance, Fire, and Scintillation, which analyze the light handling ability of your lab grown diamond. The combination of these factors is the essence of what makes any diamond visibly shine, dance and sparkle from across a room. Fire and Scintillation are graded while the diamond is in motion and interacting with light. View the Fire and Scintillation videos of this lab grown diamond at GCALUSA.com or by scanning the QR code on this certificate.

OPTICAL EXCELLENCE

The last two 8X grading factors, Optical Symmetry and Hearts & Arrows, scrutinize the craftsmanship and the precise alignment of the crown and pavilion facets in harmony to achieve aesthetic perfection.

Grading scales for each of the 8X grading factors can be viewed at GCALUSA.com